

Article number: 07112401001

Description: Universal joint single 0.112.401.001
S=120 X= Bore with keyway

Measures

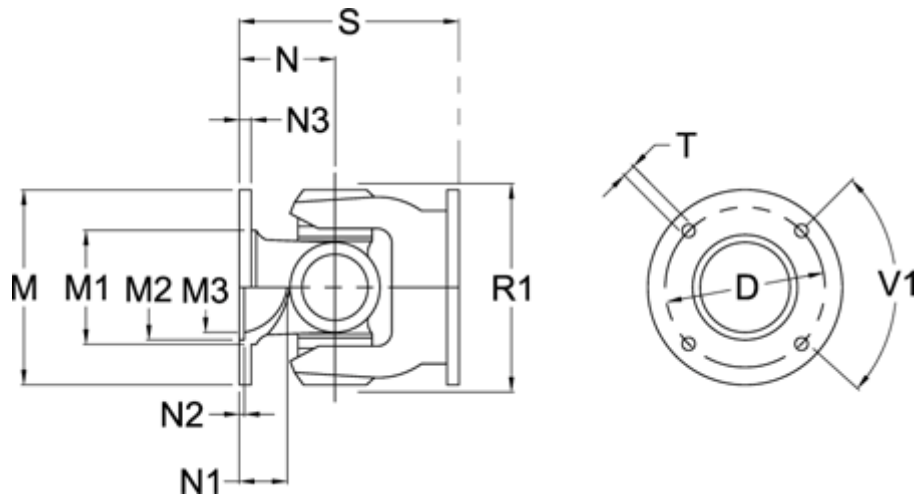

D	= 130 +0,1	N2	= 3 +0,5
Flange diameter M	= 150	N3	= 9
M1	= 101	Number og Flangeholes	= 8
M2	= 90	R1	= 115
M3	= 78	S min	= 120
Max. Bending Angle degrees	= 18	T	= 10 B12
N	= 60	V1 degrees	= 45
N1	= 33		